

Article number: 604132034020

Description: Taper bored timing belt pulley
HTD 34 8M 20 TL 1610

Measures

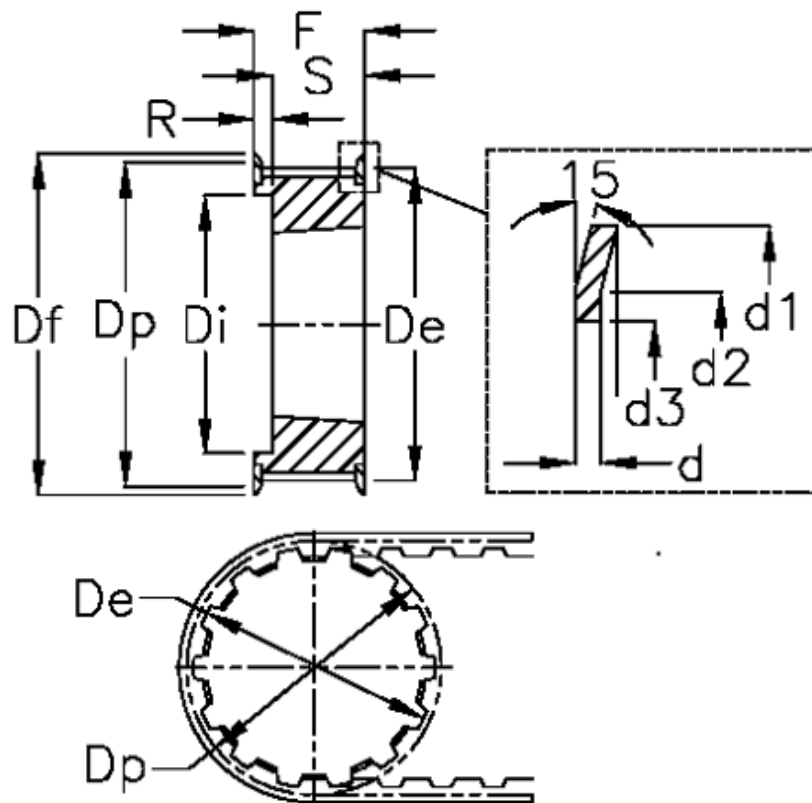

d = 1.5	F = 28	Weight = 0.55
d1 = 91	Flange type = F31	Width = 20
d2 = 85.5	For bushing = 1610	
d3 = 76	Max bore = 42	
De = 85.22	r = 3	
Df = 91	S = 25	
Di = 64	Tooth number = 34	
Dp = 86.58	Type = 8M	